

adagio

VICTORIOUS IMAGINATION

A symphony in stainless steel, harmonious and moving, yet timeless. A radiator to stir your spirit. Adagio! A radiator that is beyond any imagination.



technical specs page 132



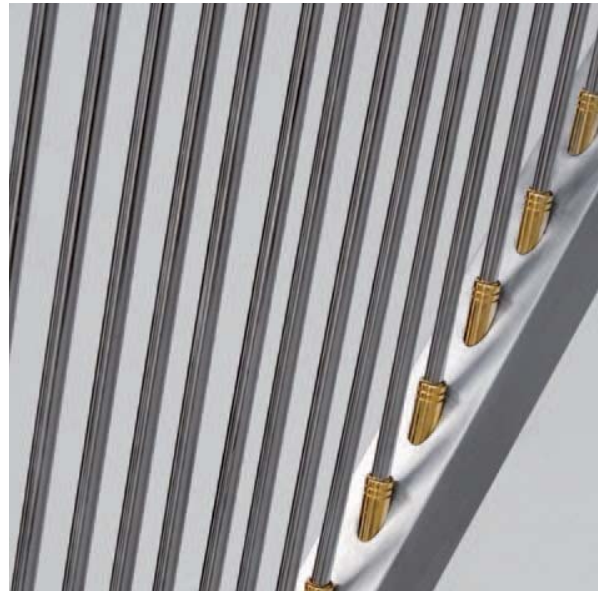

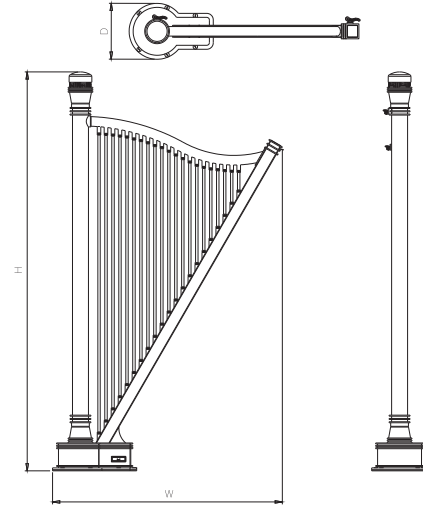
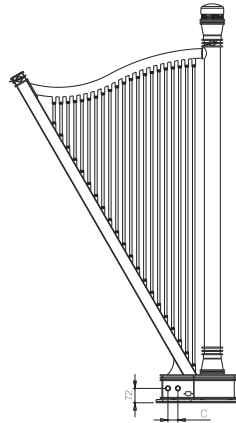
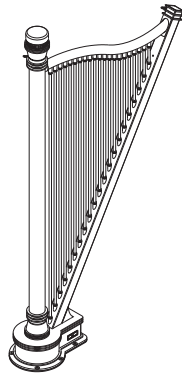

| material | finish | electric version | wall installation | warranty |
|-----------------|----------------|--------------------------|--------------------------|-----------------|
| stainless steel | satin polished | heating element included | floor standing | 10 years |

max. working pressure: 8 bar
 max. working temperature: 95°C
 all dimensions are in mm.
 connections 1/2"
 digital display screen
 customizable remote control
 changing LED lights

| Product Code | Width | Height | Depth | Connection Centers | Tube Quantity | Assembly Axis | | Weight | Water Capacity | THERMAL POWER | | |
|---------------------|--------------|---------------|--------------|---------------------------|----------------------|----------------------|----------|---------------|-----------------------|----------------------|--------------|-------------|
| | W | H | D | C | | S | L | kg. | lt. | btu | k/cal | watt |
| ADA115020002109 | 1150 | 2000 | 280 | 50 | 21 | - | - | 44 | 15,2 | 5566 | 1402 | 1631 |

Vermogen (Watt) berekend op 75/65/20 graden Delta T50
 Bij 90/70/20 graden vermenigvuldig het vermogen met 1.26

ADAGIO



carisa[®]
design radiator

The contents of this document are property of Termosan[®] and should not be copied, reproduced or disclosed to a third party without written consent of the proprietor.

www.carisa.com.tr

www.termosan.com
info@termosan.com

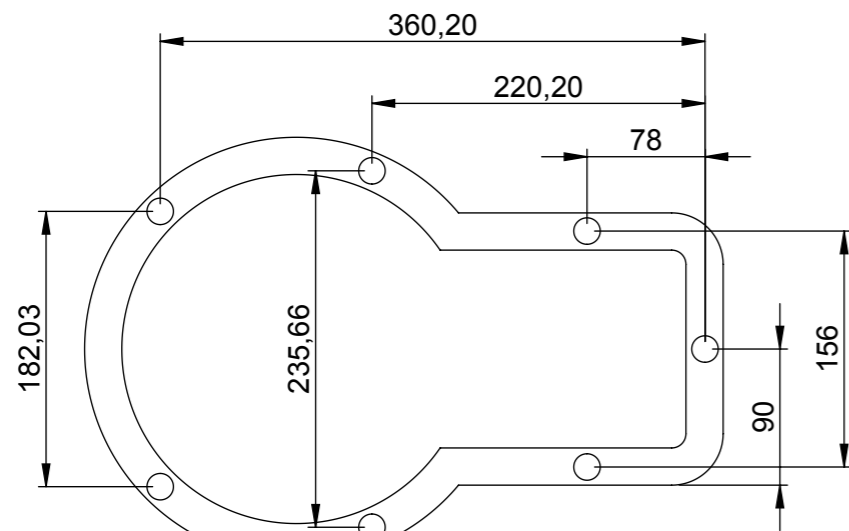
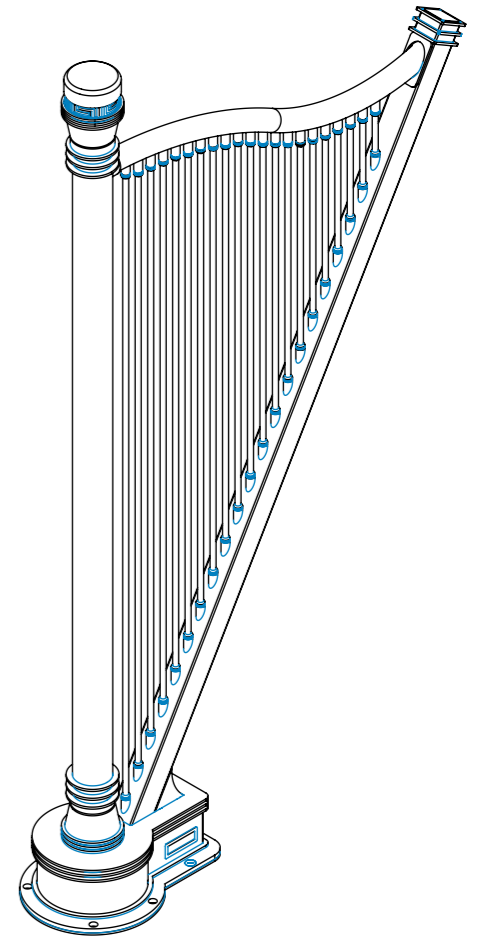
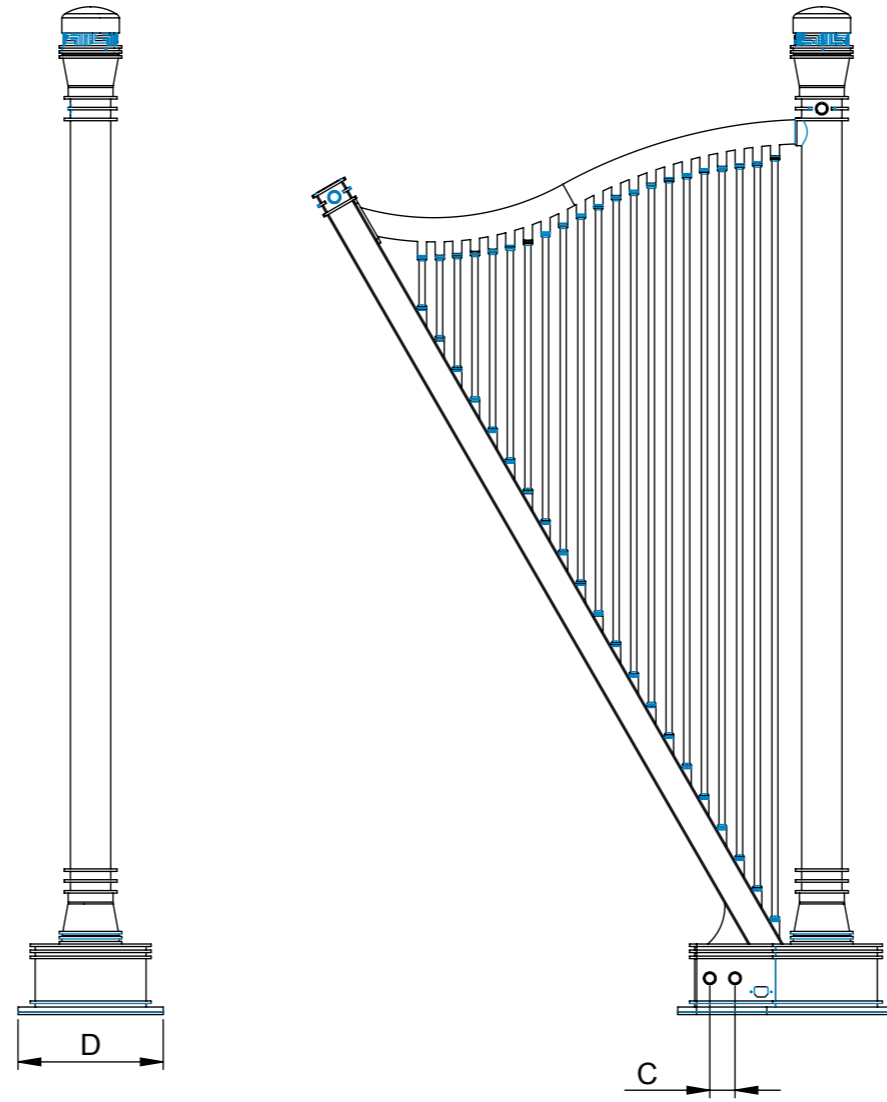
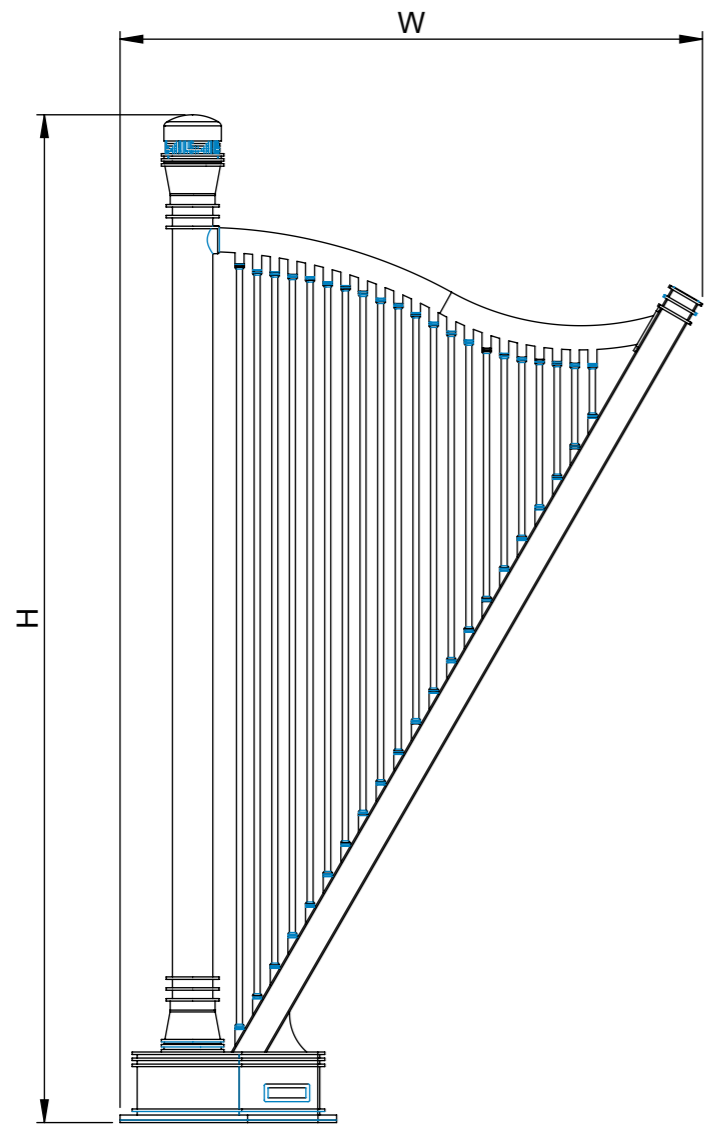

Hole Template

| Product Code | Width | Height | Depth | Connection Centers | Tube Quantity | Assembly Axis | | Weight | Water Capacity |
|-----------------|-------|--------|-------|--------------------|---------------|---------------|---|--------|----------------|
| | W | H | D | C | | S | L | kg. | lt. |
| ADA115020002109 | 1150 | 2000 | 280 | 50 | 21 | - | - | 44,0 | 15,2 |