

**AN ALUMINIUM SUCCESS STORY!**

A clean surface of aluminium in different colors, specially designed for vast projects, economic and efficient, very minimalist in design, and very aggressive in competition.

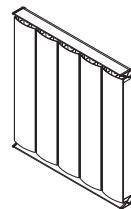

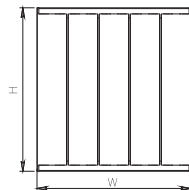
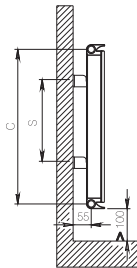
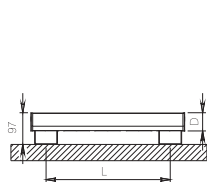

montana

| Product Code | Width | Height | Depth | Connection Centers | Tube Quantity | Assembly Axis | | Weight | Water Capacity | THERMAL POWER (Anodized) | | |
|---------------|-------|--------|-------|--------------------|---------------|---------------|------|--------|----------------|--------------------------|-------|------|
| | W | H | D | C | | S | L | kg. | lt. | btu | k/cal | watt |
| MON0565040006 | 565 | 430 | 55 | 400 | 6 | 180 | 475 | 5,3 | 0,6 | 1714 | 432 | 502 |
| MON0755040008 | 755 | 430 | 55 | 400 | 8 | 180 | 665 | 7,1 | 0,8 | 2288 | 576 | 670 |
| MON0945040010 | 945 | 430 | 55 | 400 | 10 | 180 | 855 | 8,8 | 1,0 | 2872 | 723 | 841 |
| MON1135040012 | 1135 | 430 | 55 | 400 | 12 | 180 | 1045 | 10,5 | 1,2 | 3435 | 865 | 1006 |
| MON1325040014 | 1325 | 430 | 55 | 400 | 14 | 180 | 1235 | 12,3 | 1,4 | 4009 | 1010 | 1174 |
| MON1515040016 | 1515 | 430 | 55 | 400 | 16 | 180 | 1425 | 14,0 | 1,5 | 4580 | 1153 | 1341 |
| MON1705040018 | 1705 | 430 | 55 | 400 | 18 | 180 | 1615 | 15,7 | 1,7 | 5157 | 1299 | 1510 |
| MON1895040020 | 1895 | 430 | 55 | 400 | 20 | 180 | 1805 | 17,5 | 1,9 | 5727 | 1442 | 1677 |
| MON0565050006 | 565 | 530 | 55 | 500 | 6 | 280 | 475 | 6,3 | 0,6 | 2145 | 540 | 628 |
| MON0755050008 | 755 | 530 | 55 | 500 | 8 | 280 | 665 | 8,3 | 0,9 | 2865 | 722 | 839 |
| MON0945050010 | 945 | 530 | 55 | 500 | 10 | 280 | 855 | 10,4 | 1,1 | 3579 | 901 | 1048 |
| MON1135050012 | 1135 | 530 | 55 | 500 | 12 | 280 | 1045 | 12,4 | 1,3 | 4296 | 1082 | 1258 |
| MON1325050014 | 1325 | 530 | 55 | 500 | 14 | 280 | 1235 | 14,5 | 1,5 | 5013 | 1262 | 1468 |
| MON1515050016 | 1515 | 530 | 55 | 500 | 16 | 280 | 1425 | 16,5 | 1,7 | 5727 | 1442 | 1677 |
| MON1705050018 | 1705 | 530 | 55 | 500 | 18 | 280 | 1615 | 18,5 | 1,9 | 6444 | 1623 | 1887 |
| MON1895050020 | 1895 | 530 | 55 | 500 | 20 | 280 | 1805 | 20,6 | 2,2 | 7161 | 1803 | 2097 |
| MON0565060006 | 565 | 630 | 55 | 600 | 6 | 380 | 475 | 7,3 | 0,7 | 2578 | 649 | 755 |
| MON0755060008 | 755 | 630 | 55 | 600 | 8 | 380 | 665 | 9,6 | 1,0 | 3435 | 865 | 1006 |
| MON0945060010 | 945 | 630 | 55 | 600 | 10 | 380 | 855 | 12,0 | 1,2 | 4296 | 1082 | 1258 |
| MON1135060012 | 1135 | 630 | 55 | 600 | 12 | 380 | 1045 | 14,3 | 1,4 | 5157 | 1299 | 1510 |
| MON1325060014 | 1325 | 630 | 55 | 600 | 14 | 380 | 1235 | 16,7 | 1,7 | 6014 | 1514 | 1761 |
| MON1515060016 | 1515 | 630 | 55 | 600 | 16 | 380 | 1425 | 19,0 | 1,9 | 6874 | 1731 | 2013 |
| MON1705060018 | 1705 | 630 | 55 | 600 | 18 | 380 | 1615 | 21,4 | 2,2 | 7735 | 1948 | 2265 |
| MON1895060020 | 1895 | 630 | 55 | 600 | 20 | 380 | 1805 | 23,7 | 2,4 | 8596 | 2165 | 2517 |
| MON0375150004 | 375 | 1530 | 55 | 1500 | 4 | 1280 | 285 | 10,8 | 0,9 | 4296 | 1082 | 1258 |
| MON0755150006 | 755 | 1530 | 55 | 1500 | 8 | 1280 | 665 | 21,1 | 1,8 | 8596 | 2165 | 2517 |
| MON0375180004 | 375 | 1830 | 55 | 1800 | 4 | 1580 | 285 | 12,8 | 1,0 | 5157 | 1299 | 1510 |
| MON0565180006 | 565 | 1830 | 55 | 1800 | 6 | 1580 | 475 | 18,8 | 1,5 | 7735 | 1948 | 2265 |

material *aluminium*

finish *anodized*

electric version *600 W / 900 W / 1200 W*

wall installation *vertical / horizontal*

warranty *5 years*

*max. working pressure: 5 bar
max. working temperature: 95°C
all dimensions are in mm.
connections 1/2"*

Vermogen (Watt) berekend op 75/65/20 graden Delta T50
Bij 90/70/20 graden vermenigvuldigd het vermogen met 1.26

MONTANA

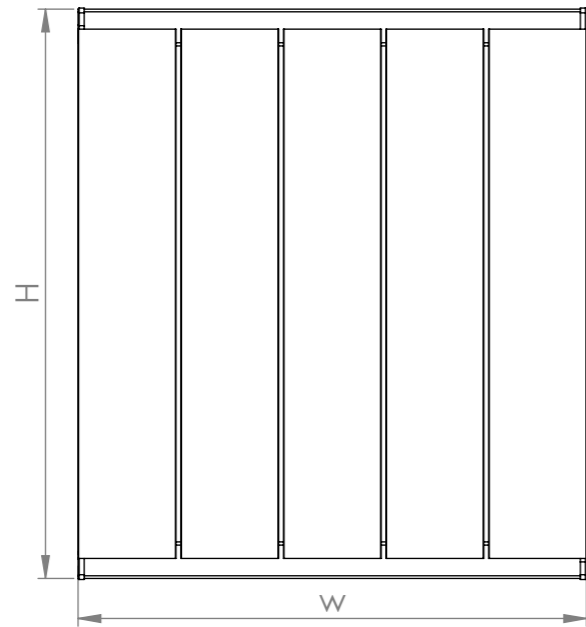
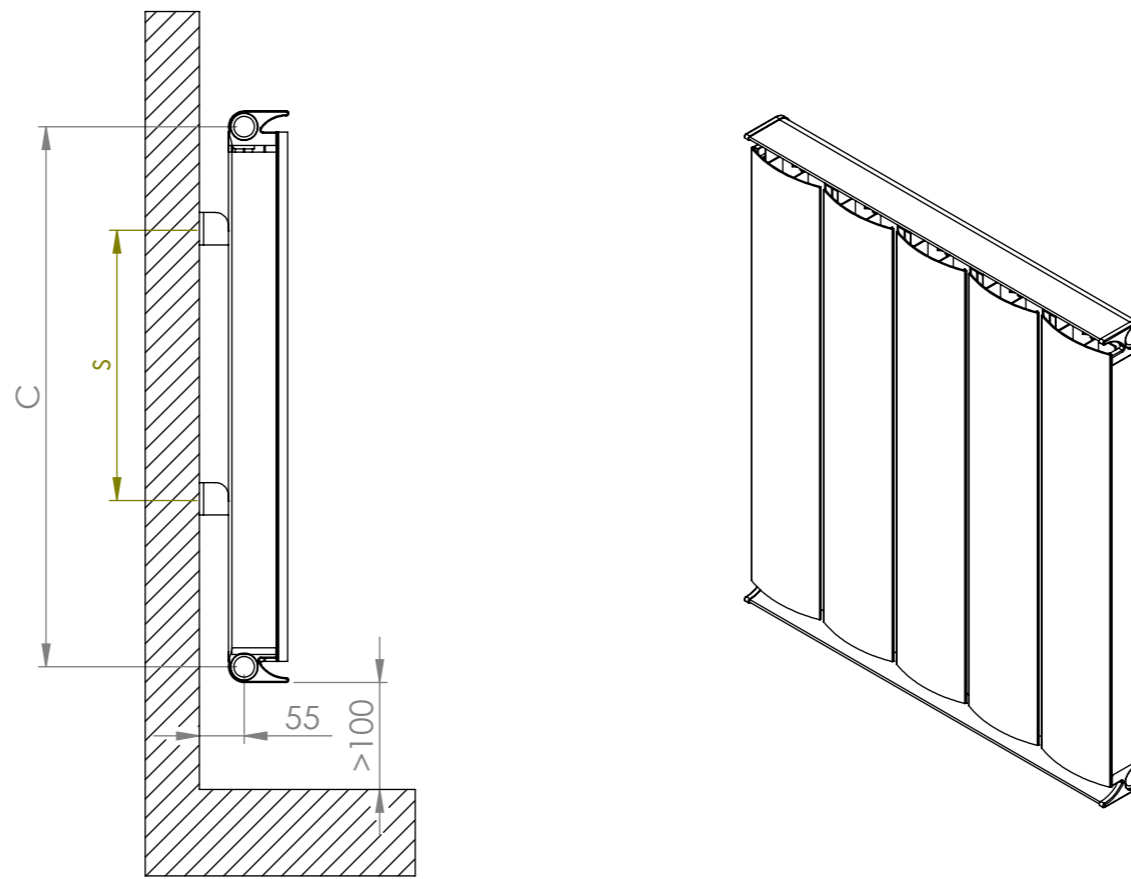
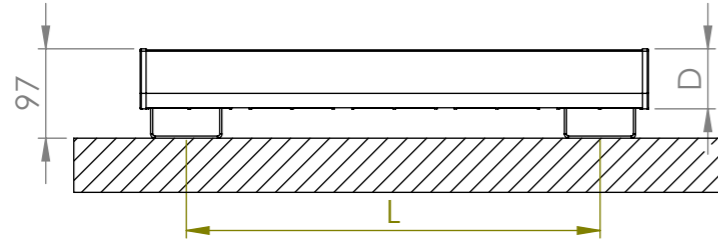

The contents of this document are property of Termosan® and should not be copied, reproduced or disclosed to a third party without written consent of the proprietor.

www.carisa.com.tr

www.termosan.com
info@termosan.com

| Product Code | Width | Height | Depth | Connection Centers | Tube Quantity | Assembly Axis | | Weight | Water Capacity |
|---------------|-------|--------|-------|--------------------|---------------|---------------|------|--------|----------------|
| | W | H | D | C | | S | L | kg. | lt. |
| MON0565040006 | 565 | 430 | 55 | 400 | 6 | 180 | 475 | 5,3 | 0,6 |
| MON0755040008 | 755 | 430 | 55 | 400 | 8 | 180 | 665 | 7,1 | 0,8 |
| MON0945040010 | 945 | 430 | 55 | 400 | 10 | 180 | 855 | 8,8 | 1,0 |
| MON1135040012 | 1135 | 430 | 55 | 400 | 12 | 180 | 1045 | 10,5 | 1,2 |
| MON1325040014 | 1325 | 430 | 55 | 400 | 14 | 180 | 1235 | 12,3 | 1,4 |
| MON1515040016 | 1515 | 430 | 55 | 400 | 16 | 180 | 1425 | 14,0 | 1,5 |
| MON1705040018 | 1705 | 430 | 55 | 400 | 18 | 180 | 1615 | 15,7 | 1,7 |
| MON1895040020 | 1895 | 430 | 55 | 400 | 20 | 180 | 1805 | 17,5 | 1,9 |
| MON0565050006 | 565 | 530 | 55 | 500 | 6 | 280 | 475 | 6,3 | 0,6 |
| MON0755050008 | 755 | 530 | 55 | 500 | 8 | 280 | 665 | 8,3 | 0,9 |
| MON0945050010 | 945 | 530 | 55 | 500 | 10 | 280 | 855 | 10,4 | 1,1 |
| MON1135050012 | 1135 | 530 | 55 | 500 | 12 | 280 | 1045 | 12,4 | 1,3 |
| MON1325050014 | 1325 | 530 | 55 | 500 | 14 | 280 | 1235 | 14,5 | 1,5 |
| MON1515050016 | 1515 | 530 | 55 | 500 | 16 | 280 | 1425 | 16,5 | 1,7 |
| MON1705050018 | 1705 | 530 | 55 | 500 | 18 | 280 | 1615 | 18,5 | 1,9 |
| MON1895050020 | 1895 | 530 | 55 | 500 | 20 | 280 | 1805 | 20,6 | 2,2 |
| MON0565060006 | 565 | 630 | 55 | 600 | 6 | 380 | 475 | 7,3 | 0,7 |
| MON0755060008 | 755 | 630 | 55 | 600 | 8 | 380 | 665 | 9,6 | 1,0 |
| MON0945060010 | 945 | 630 | 55 | 600 | 10 | 380 | 855 | 12,0 | 1,2 |
| MON1135060012 | 1135 | 630 | 55 | 600 | 12 | 380 | 1045 | 14,3 | 1,4 |
| MON1325060014 | 1325 | 630 | 55 | 600 | 14 | 380 | 1235 | 16,7 | 1,7 |
| MON1515060016 | 1515 | 630 | 55 | 600 | 16 | 380 | 1425 | 19,0 | 1,9 |
| MON1705060018 | 1705 | 630 | 55 | 600 | 18 | 380 | 1615 | 21,4 | 2,2 |
| MON1895060020 | 1895 | 630 | 55 | 600 | 20 | 380 | 1805 | 23,7 | 2,4 |
| MON0375150004 | 375 | 1530 | 55 | 1500 | 4 | 1280 | 285 | 10,8 | 0,9 |
| MON0755150006 | 755 | 1530 | 55 | 1500 | 8 | 1280 | 665 | 21,1 | 1,8 |
| MON0375180004 | 375 | 1830 | 55 | 1800 | 4 | 1580 | 285 | 12,8 | 1,0 |
| MON0565180006 | 565 | 1830 | 55 | 1800 | 6 | 1580 | 475 | 18,8 | 1,5 |

